



indigo^off

ACOUSTIC CEILING

PLAFÓN ACÚSTICO



technical specs

especificación técnica

PRODUCT / PRODUCTO	ACOUSTIC PANEL
COMPOSITION / COMPOSICIÓN	100% PET
DIMENSIONS / DIMENSIONES	10"X 47.2" / 10" X 94"
THICKNESS / ESPESOR	3/8" (9 mm) / 1/2" (12 mm)
STANDARD COLORS / COLORES ESTÁNDAR	18 colors
FIRE RETARDANT / RETARDANTE AL FUEGO	Class A / ASTM E84
ACOUSTIC ABSORPTION / ABSORCIÓN ACÚSTICA	NRC 0.65 - 0.95



STANDARD COLORS

COLORES ESTÁNDAR

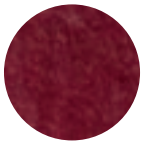

CHERRY



RED



ORANGE

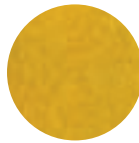

CITRUS

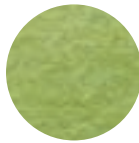

GREEN

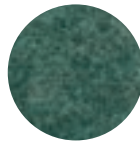

FOREST GREEN



MOKA



PEACH



VIOLET

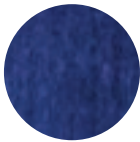

NAVY BLUE



BLUE

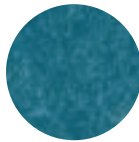

TEAL



DEEP BLUE



BLACK



OXFORD



LIGHT GREY



IVORY



WHITE

HOLDING SYSTEM COLORS

COLORES DEL SISTEMA DE SUJECIÓN

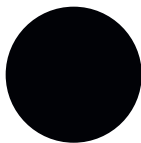

BLACK



OXFORD



GREY

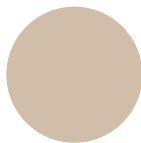

IVORY

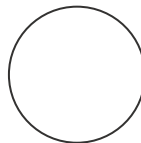

WHITE



DIMENSIONS
DIMENSIONES

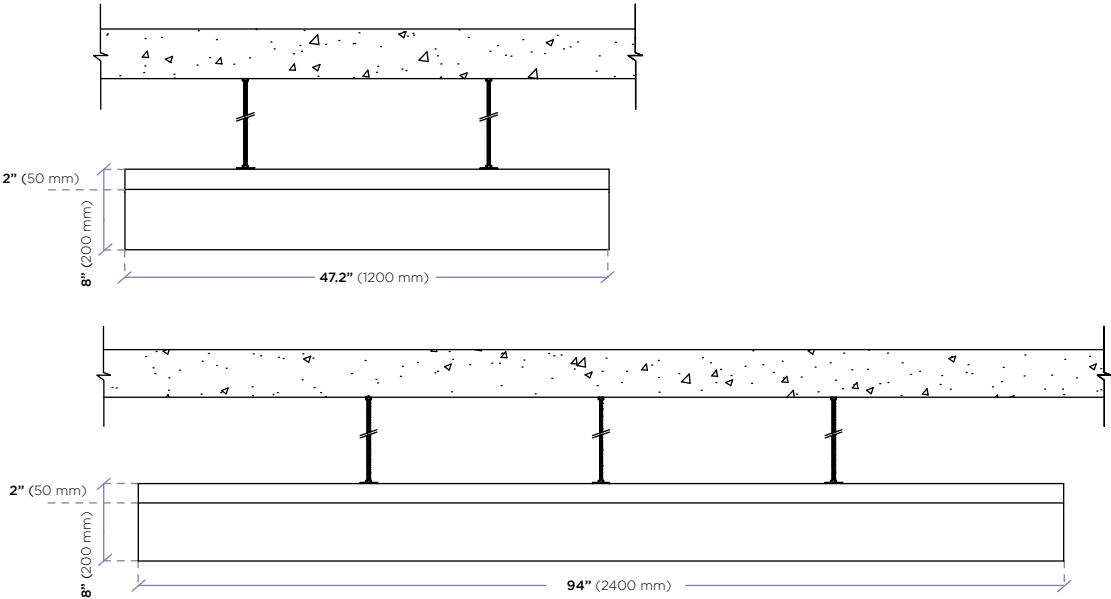

ISOMETRIC
ISOMÉTRICO

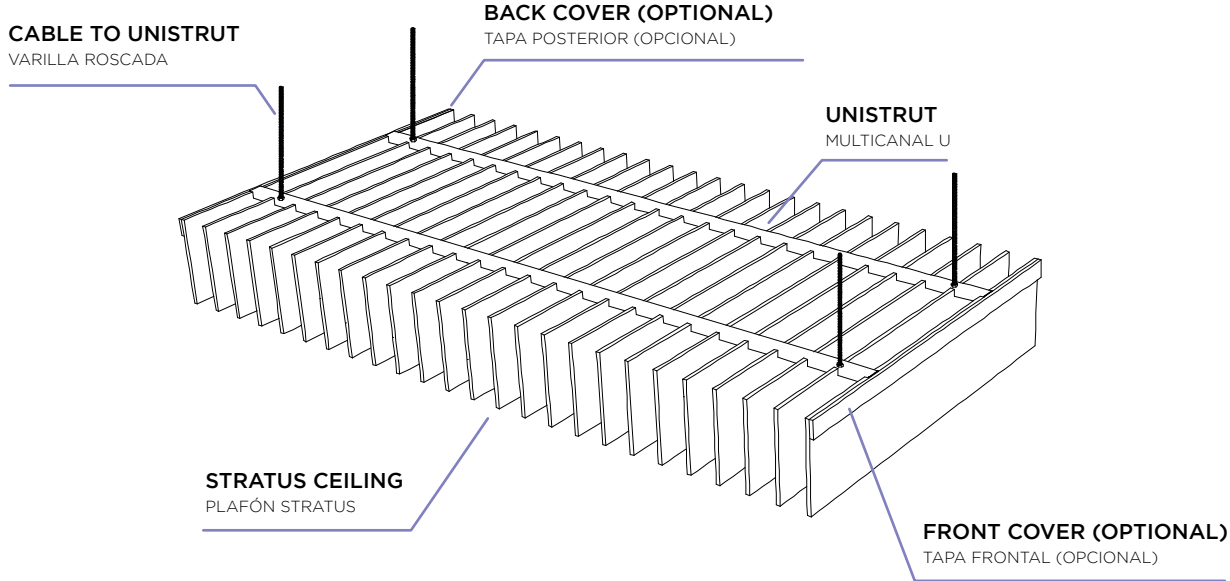

BAFFLE SEPARATIONS

SEPARACIONES DE BAFFLE



CABLE TO UNISTRUT
VARILLA ROSCADA

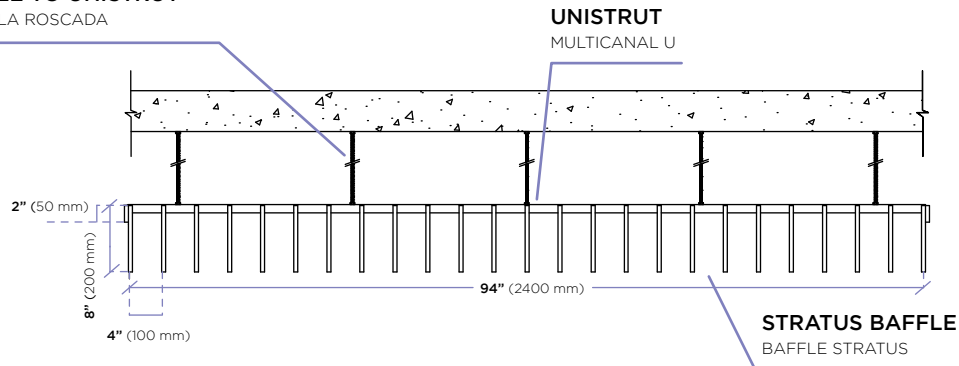

CABLE TO UNISTRUT
VARILLA ROSCADA

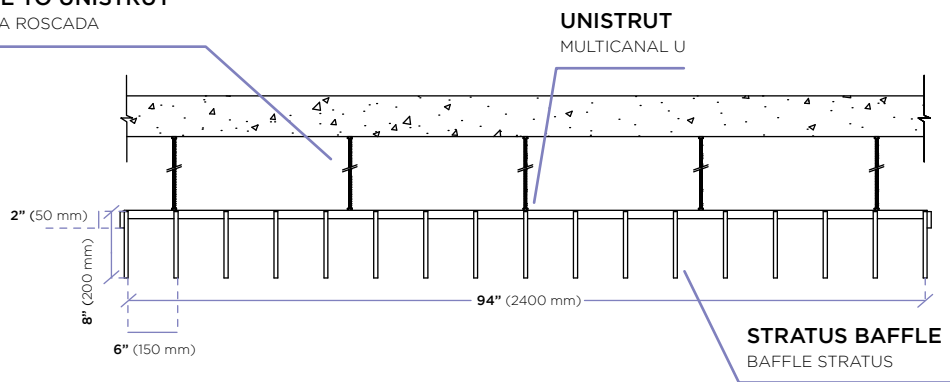

CABLE TO UNISTRUT
VARILLA ROSCADA

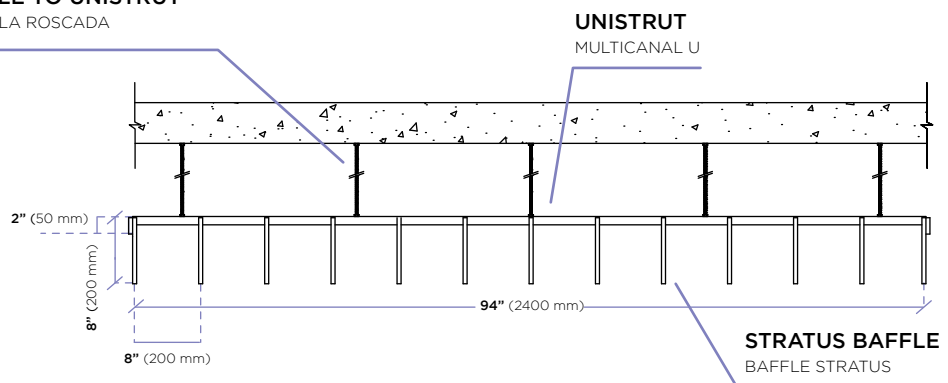

NOTE: THE MEASUREMENTS REPORTED IN THIS TECHNICAL SHEET ARE STANDARDIZED AND EXPRESSED IN INCHES (") AND MILLIMETERS (MM), HOWEVER THESE MAY VARY ACCORDING TO PROJECT.

NOTA: LAS MEDIDAS SEÑALADAS EN ESTA FICHA TÉCNICA ESTÁN ESTANDARIZADAS Y EXPRESADAS EN PULGADAS (") Y MILÍMETROS (MM), SIN EMBARGO ESTAS PUEDEN VARIAR DE ACUERDO A UN PROYECTO ESPECÍFICO.



The new way to look up

indigoff.design